

## 1398nm DFB Laser diode for H<sub>2</sub>O Sensing (TO39 Package)



### Description:

The PL-DFB-1398-A-A81 1398nm DFB laser diode module made by LD-PD is a cost effective, highly coherent laser source. The DFB laser diode chip is packaged in an industry standard hermetically sealed TO39 package with TEC and PD Built in.

### Features:

- Narrow Linewidth < 2MHz
- Excellent wavelength control and stability
- Industry Standard 14 pin Butterfly package
- Mode-Hop free tuning
- Excellent reliability
- Customer specific wavelengths available

### Application:

- Tunable diode laser absorption spectroscopy
- H<sub>2</sub>O Monitoring

## Laser Specifications:

Electrical/Optical Characteristics (Tsub=25°C, CW bias unless stated otherwise)

Parameter	Symbol	Min	Typ	Max	Unit
Centre Wavelength	$\lambda$	1397.5	1398.0	1398.5	nm
Side Mode Suppression Ratio	SMSR	30	40		dB
Threshold Current	I <sub>th</sub>		20	30	mA
Operating Current	I <sub>op</sub>		80	120	mA
Chip output Power	P <sub>f</sub>	15	20	30	mW
Quantum Efficiency	$\eta$	0.08	0.12		mW/mA
Current Tuning Coefficient	$\Delta\lambda/\Delta I$		0.015		nm/mA
Temperature Tuning Coefficient	$\Delta\lambda/\Delta T$		0.12		nm/K
Forward Voltage	V <sub>f</sub>		1.3	2	V
Thermistor Resistance	RT	9.5	10	10.5	K $\Omega$
Thermistor Temp. Coefficient			-4.4		%/°C

## Spectrum:

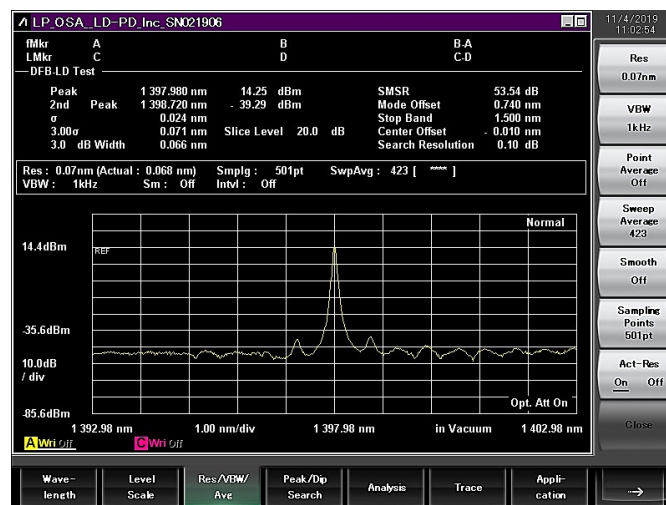

**L-I Curve:**

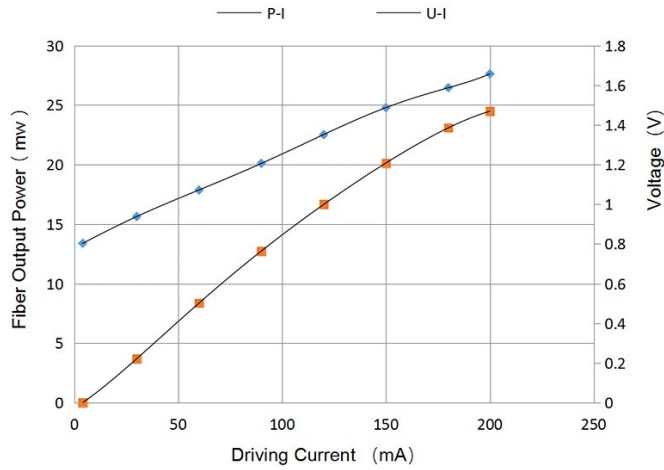

**DFB Linewidth Testing Result:**

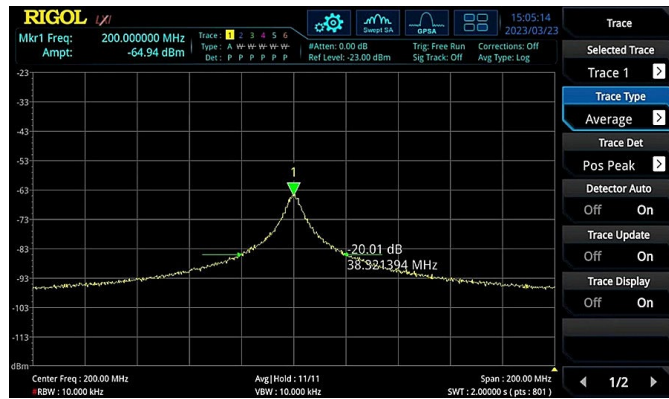

**Wavelength Stability:**

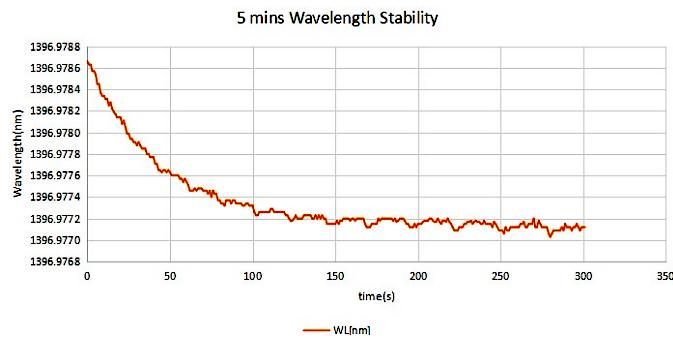

**Mode hopping tuning Range:**

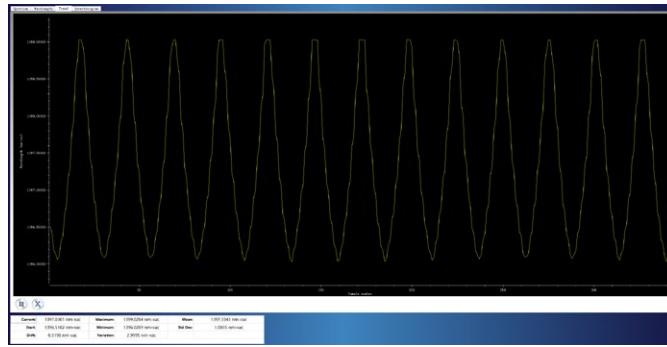

**Beam Quality:**

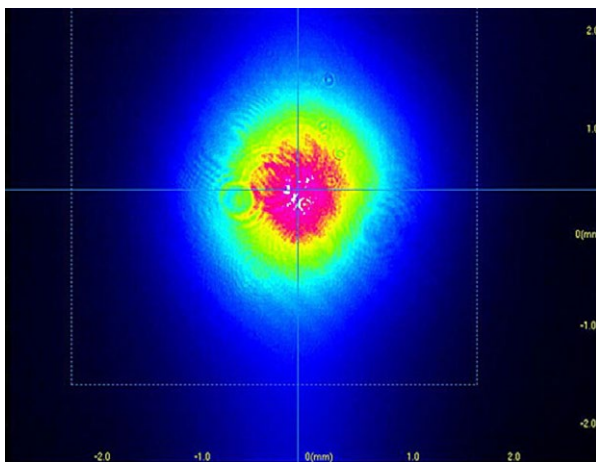

2D

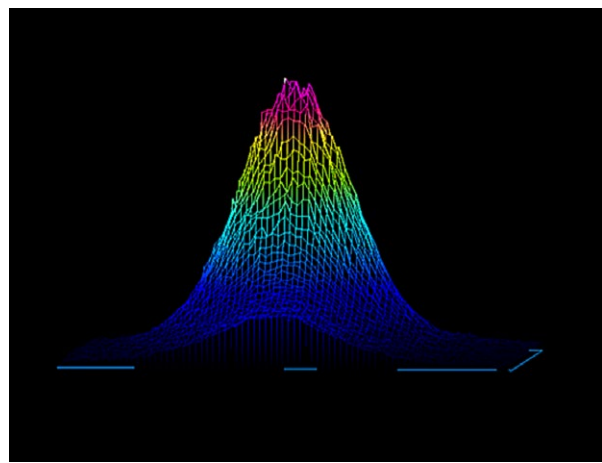

3D

**Camera Analysis:**

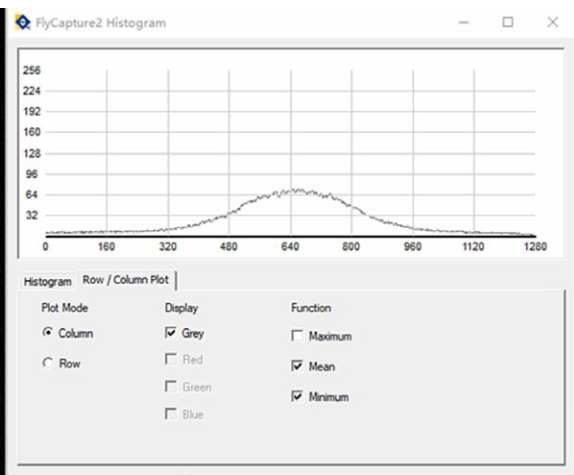
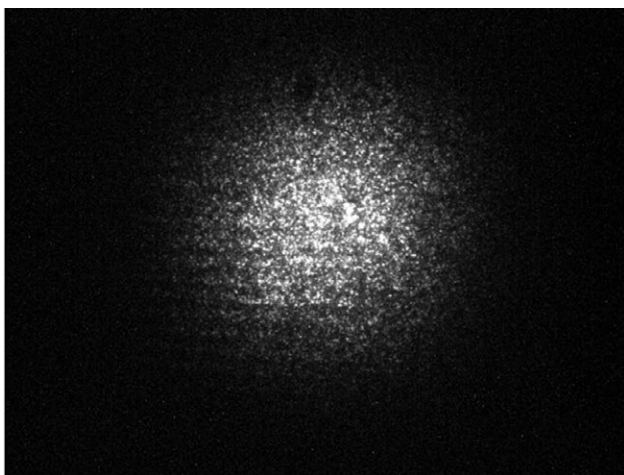

**Dimensions and Pin definitions:**

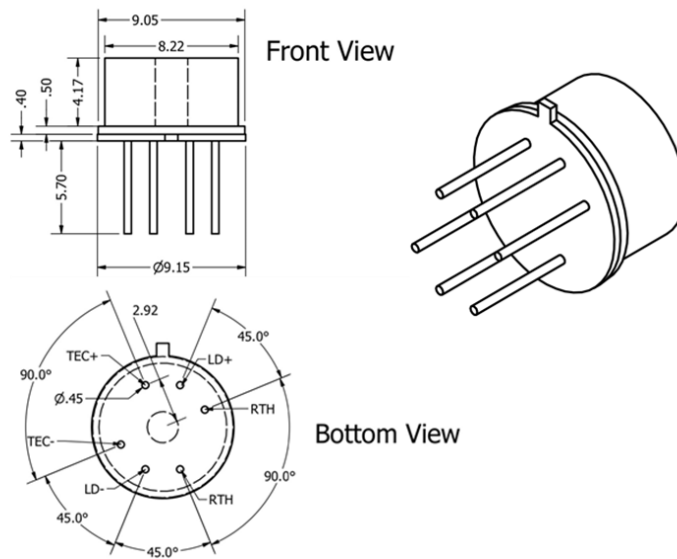

**Absolute Maximum Ratings:**

Item	Unit	Min	Typ	Max
Case Temperature	°C	-5	25	70
Chip Temperature	°C	+10	25	40
Operating Current	mA	0	100	120
Forward Voltage	V	0.8	1.2	1.8
TEC Current	A	-	-	1.2
Reverse Voltage (LD)	V	-	-	2.0
Reverse Voltage (PD)	V	-	-	20

**H<sub>2</sub>O:**

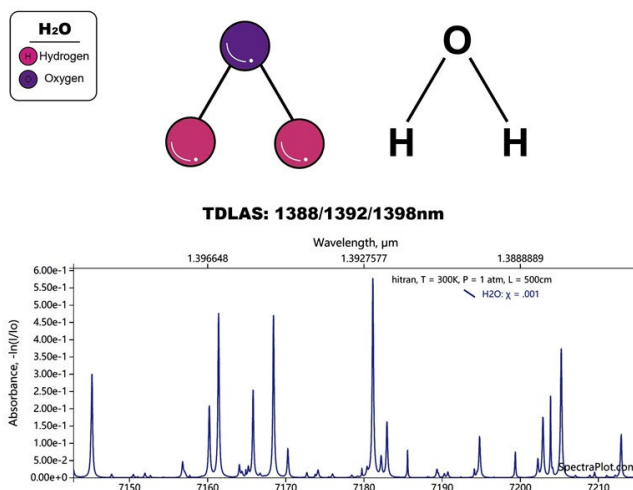

**Ordering Info:**

PL-DFB-□□□□-☆-A8▽-TO39

□□□□: Wavelength

1398: 1398nm

\*\*\*\*\*

1653.7: 1653.7nm

☆ : Output Power

A: 15mW

B: 30mW

▽ : Wavelength Tolerance

1: ±1nm

2: ±2nm