

1532nm DFB Laser diode for C₂H₂ Sensing (TO39 Package)

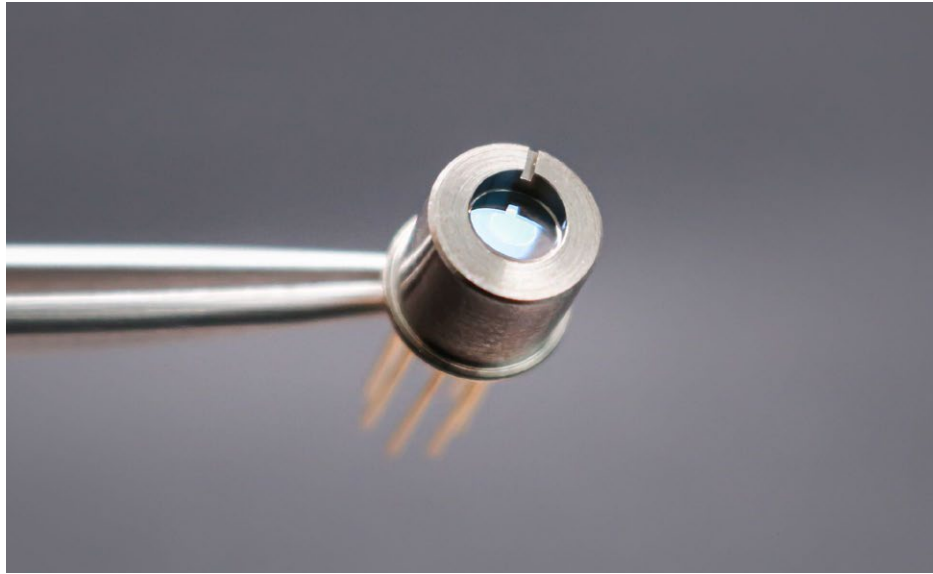

Description:

The PL-DFB-1532-A-A81 1532nm DFB laser diode module made by LD-PD is a cost effective, highly coherent laser source. The DFB laser diode chip is packaged in an industry standard hermetically sealed TO39 package with TEC and PD Built in.

Features:

- Narrow Linewidth < 2MHz
- Excellent wavelength control and stability
- Industry Standard 14 pin Butterfly package
- Mode-Hop free tuning
- Excellent reliability
- Customer specific wavelengths available

Application:

- Tunable diode laser absorption spectroscopy
- C₂H₂ Monitoring

Laser Specifications:

Tsub=25°C, CW bias unless stated otherwise

Parameter	Symbol	Min	Typ	Max	Unit
Centre Wavelength	λ	1531.5	1532.0	1532.5	nm
Side Mode Suppression Ratio	SMSR	30	40		dB
Threshold Current	I _{th}		20	30	mA
Operating Current	I _{op}		80	120	mA
Chip output Power	P _f	10	15	30	mW
Quantum Efficiency	η	0.08	0.12		mW/mA
Current Tuning Coefficient	$\Delta\lambda/\Delta I$		0.015		nm/mA
Temperature Tuning Coefficient	$\Delta\lambda/\Delta T$		0.12		nm/K
Forward Voltage	V _f		1.3	2	V
Thermistor Resistance	RT	9.5	10	10.5	K Ω
Thermistor Temp. Coefficient			-4.4		%/°C

Spectrum:

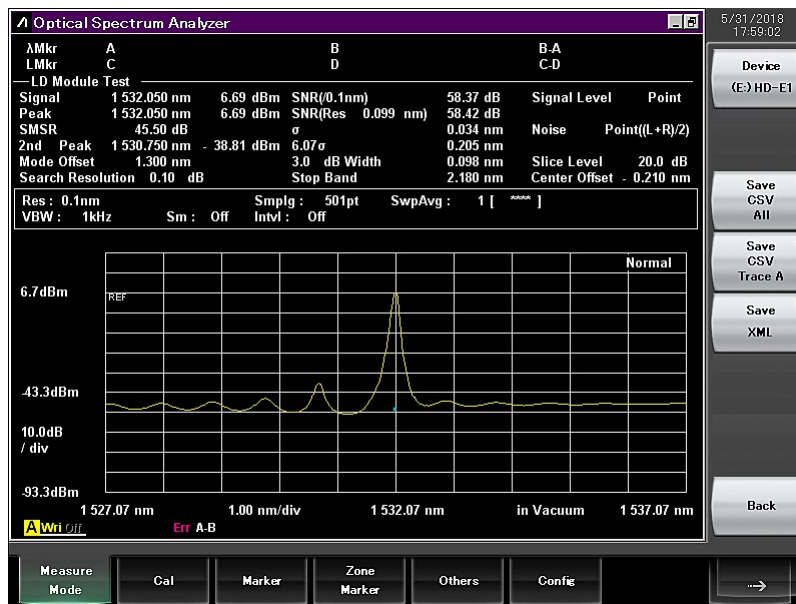

Tuning Characteristics:

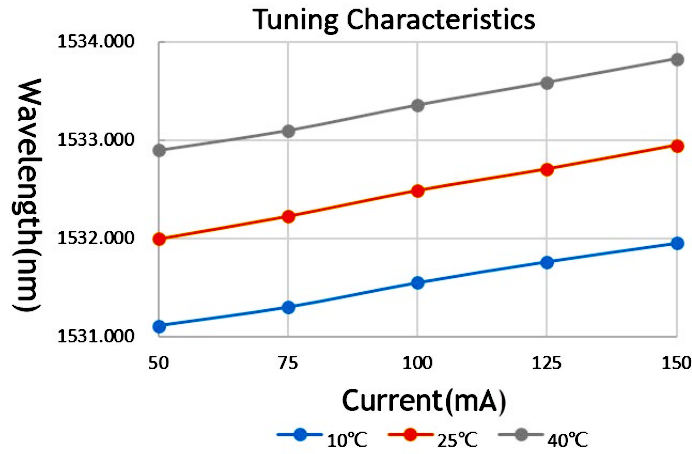

L-I Curve:

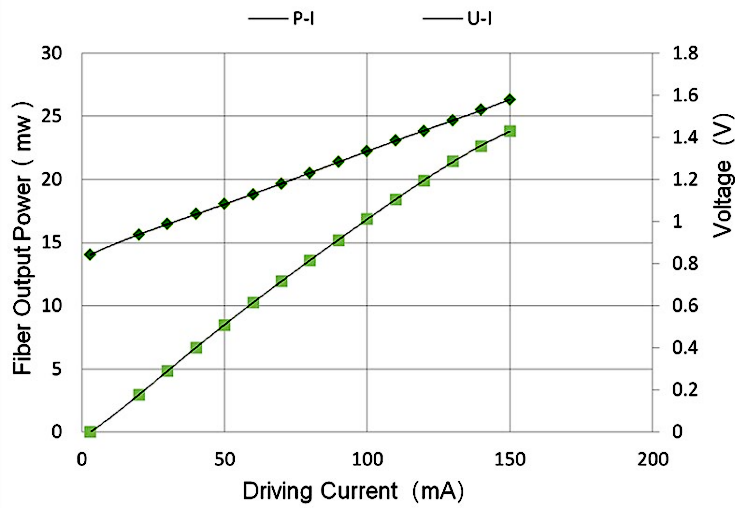

DFB Linewidth Testing Result:

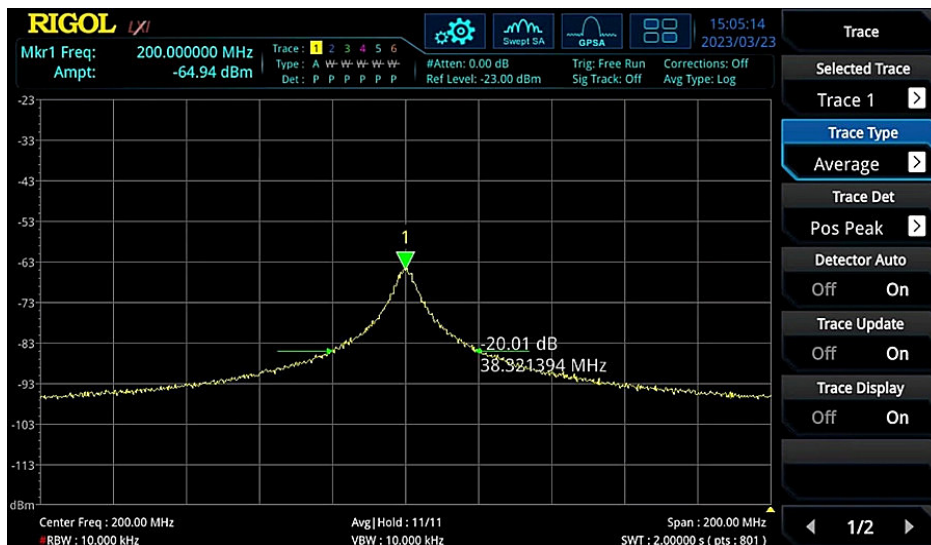

Wavelength Stability:

5mins Wavelength stability Test

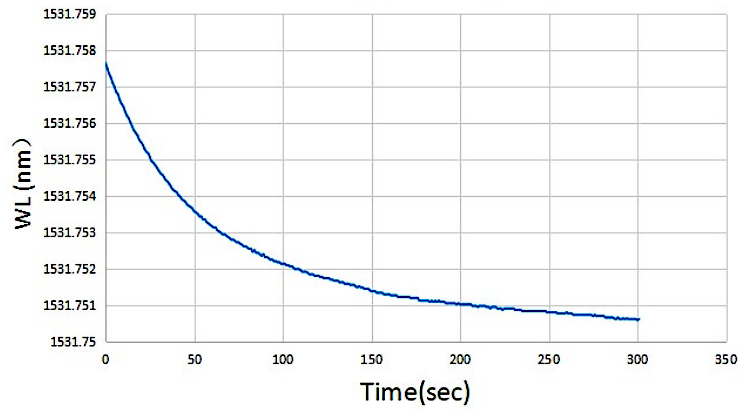

Beam Quality:

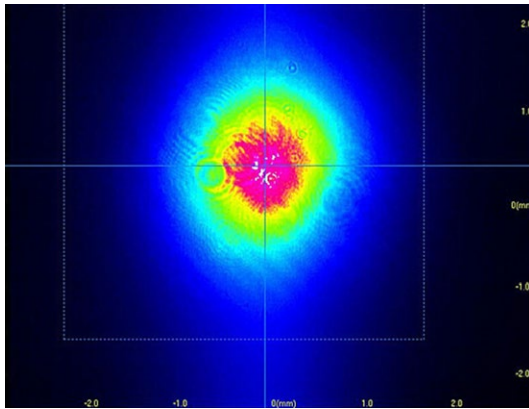

2D

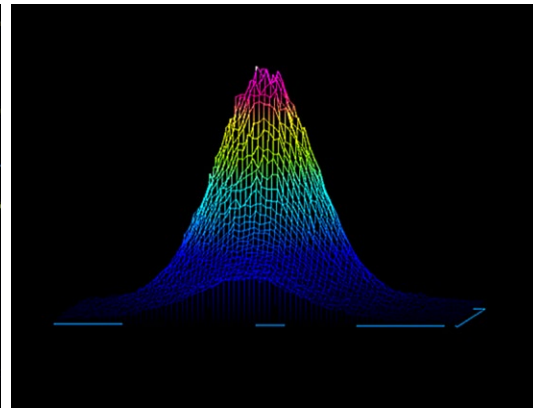

3D

Camera Analysis:

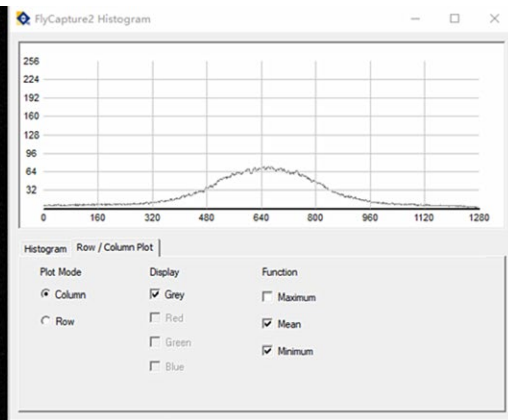
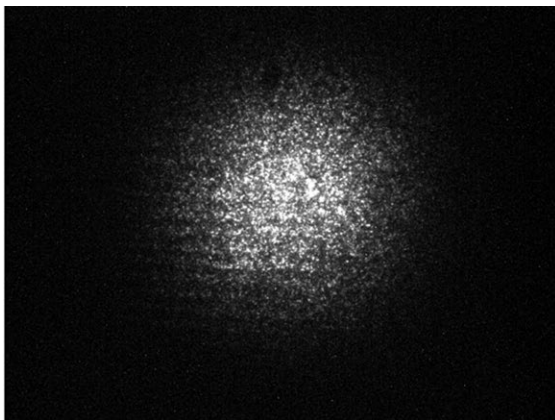

Dimensions and Pin definitions:

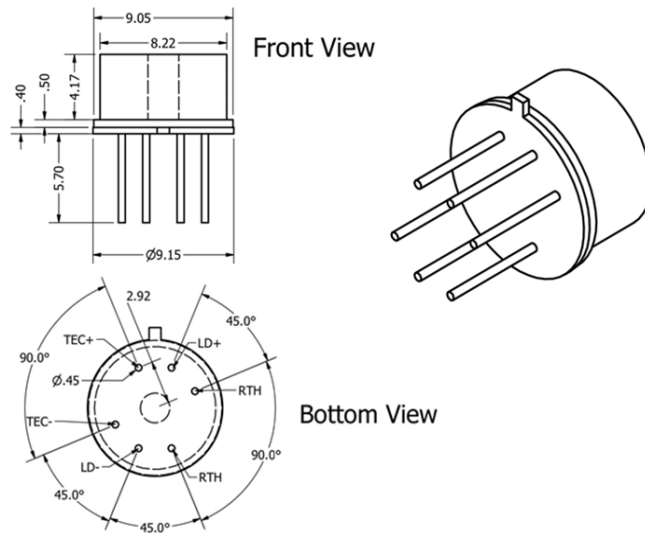

Absolute Maximum Ratings:

Item	Unit	Min	Typ	Max
Case Temperature	°C	-5	25	70
Chip Temperature	°C	+10	25	40
Operating Current	mA	0	100	120
Forward Voltage	V	0.8	1.2	1.8
TEC Current	A	-	-	1.2
Reverse Voltage (LD)	V	-	-	2.0
Reverse Voltage (PD)	V	-	-	20

C₂H₂:

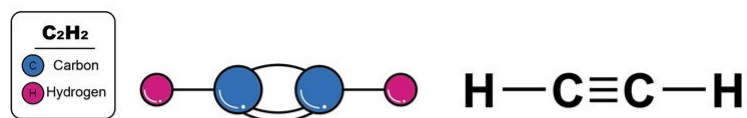

TDLAS: 1520/1532nm

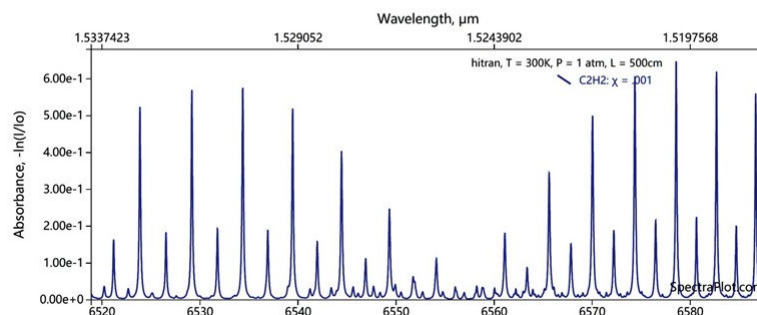

Ordering Info:

PL-DFB-□□□□-☆-A8▽-TO39

□□□□: Wavelength

1532: 1532nm

1653.7: 1653.7nm

☆: Output Power

A: 10mW

B: 20mW

▽: Wavelength Tolerance

1: ±1nm

2: ±2nm